



United States Department of Agriculture



Creating Meaningful Change for Soil Health

Matthew Denton, Soil Health Division East Region Team Leader &
Kaitlin Farbotnik, NRCS Northeast Regional Soil Health Specialist (Acting)
April 19, 2022

Natural
Resources
Conservation
Service

nrcs.usda.gov/

Matthew Denton

Soil Health Division East Region Team Leader

E-mail: Matthew.denton@usda.gov

Phone: 731-202-1373

Kaitlin Farbotnik

Northeast Regional Soil Health Specialist (Acting)

E-mail: Kaitlin.farbotnik@usda.gov

Phone: 732-519-1195

USDA is an equal opportunity provider, employer, and lender.

Contents

Background.....	3
Understanding Erosion.....	3
Four Principles of Soil Health Explained.....	3
Overview of Matthew Denton’s Grazing Operation.....	5
Overview of Kaitlin Farbotnik’s Operation (Shady Fox Farm).....	7
Breakout #1.....	8
Managing the Land.....	9
Importance of Lime.....	9
Compaction and Bulk Density.....	10
Planning to Avoid Pugging.....	12
Factsheet: Managing Cattle Impacts When Grazing on Wet Soils.....	13
Overview of Grazing, Compaction, Bulk Density, and Soil Moisture.....	17
Managing the Plants.....	18
Benefits of Multi-Species Forages.....	18
Diversity in Growing Seasons.....	19
Soil Health Lessons with Winter and Summer Annuals (Shady Fox Farm).....	19
Utilization Rate.....	20
Understanding Stocking Density.....	21
Nutrient Distribution of Managed Grazing Land.....	21
Root Response to Grazing.....	22
Factsheet: Falling Plate Meter for Estimating Pasture Forage Mass.....	23
Lesson’s About Customizing Plant Heights for Small Ruminants (Matthew Denton).....	26
Helpful Links to Small Ruminant Information.....	26
Managing the Animals.....	26
Benefits of Multi-Species Grazers.....	27
Dung Beetles and Soil Health.....	27
Overwintering Solutions to Maintain Soil Health.....	29
Dry Lots.....	29
Compost Bedded Pack Barns.....	30
Bale Grazing.....	31
Breakout #2.....	32
Overview of Grazing Systems.....	33

Background

Understanding Erosion

One of the first steps to improving soil health needs to be reducing erosion because we can't improve a resource that we are losing or have lost. Erosion is a three step process:

1. Availability and detachment – soil particles need to be available for erosion to occur; detachment can be caused by impacts from raindrops, wind, or in a grazing system soil can be detached by excessive hoof action.
2. Transport – transport will occur when soil particles are moved by water or wind from one location in the field to another. They can be transported just a few feet or up to hundreds of feet depending on the amount of cover, soil type, and slope.
3. Deposition – Deposition occurs when those soil particles “settle” on the surface in a new location. You can recognize deposition visually if you see sediment plumes, one side of a fence line or hedgerow being more elevated than the other side, or if deposition occurs in a water source it is called sedimentation.

Preventing overgrazing and maintaining proper soil cover by using our forages is the best way to reduce erosion in a grazing system.

Four Principles of Soil Health Explained



Once we have controlled erosion, we can begin thinking about improving our soil health by taking steps to implement the four soil health principles:

1. Minimize disturbance (MD) – minimizing disturbance is directly related to reducing erosion. Managing our pastures and hay fields to reduce over grazing or over mowing is key to minimizing disturbance. Overgrazing will lead to excessive hoof action and over mowing, or not maintaining mowing equipment and allowing cutters to scalp the surface or pull up roots can contribute to increased disturbance, and lower soil health.
2. Maximize soil cover (SC) – Maximizing the soil cover can be accomplished by following the ideal grazing and mowing heights. If you are using annuals in your system, or even replanting a perennial field you might want to consider using a nurse crop to get quick growth and soil coverage until the slower growing forages are more established. Again, proper grazing is a common theme, and will prevent overgrazing of forages and bare spots in the fields. Bare spots can make your fields vulnerable to erosion, weeds, and overall poor production.
3. Maximize the living root (CR) – Try to keep a continuously living root, or at least dormant roots all year long. In a perennial system this is easily accomplished. If you are using annuals this will require some more careful planning to make sure you are able to plant a series of warm season forages and cool season forages that will overwinter.
4. Maximize biodiversity (BD) – This may be one of the hardest principles to implement, but it has great positive impacts on your soil, utilization rates, and your pocket. We should be thinking about increasing the diversity of the above ground plants AND animals, which will increase the biodiversity of our below ground soil system.

As we go through this presentation, you will see four circles on each slide/page that presents a grazing technique or tool. Each of these circles represent the soil health principles with the abbreviations as noted above. The circles are color coded as follows:

- Green: the technique/tool has a direct and positive impact to the soil health principle
- Yellow: the technique/tool has an indirect and positive impact to the soil health principle
- Blue: the technique/tool is unrelated to the soil health principle

General Overview of Operation

- **Grazing with annuals – sorghum sudan and millet**



- **Grazing multi-species winter cover**
- **Grazing in vegetables fields**



Natural
Resources
Conservation
Service
nrcs.usda.gov/



Fall/Winter Cover Crop (Grazed)

- 50# Triticale or cereal rye
- 20# Annual Ryegrass
- 10# Crimson Clover
- 5# Hairy Vetch
- 5# Austrian Winter Pea
- 5# Buckwheat (optional depending on earliness)
- 5# Sunflower (optional depending on earliness)
- 1# Daikon Radish

Summer Annual Mix

- 35# Sorghum-sudangrass*
- 35# or iron clay cowpeas
- *20# of pearl millet can be subbed for sorghum-sudangrass (shorter height & no prussic acid concerns)

I have also tried mung beans, soybeans, and sun hemp with the grasses above but the sorghum-sudan mix has worked the best for me for small ruminants. I have added some forage collards as well, but the grass seems to outcompete it and eventually shade it out.

My herd has Sericea lespedeza hay available nearly year around to help with parasite issues. The pasture has a mixture of cool and warm season annuals with rotation using hot net fence. I also try to

graze as much cropland as possible for soil and animal health benefits. Management is the key for livestock integration onto cropland, but small ruminants do not present as much of a challenge compared to larger animals due to reduced compaction issues and the sheet amount of forage that they leave behind from trampling. Don't forget to take no more than half of the biomass at any one time.



Soil Health = Animal Health

- Internal parasites
- Sericea Lespedeza



Photo courtesy of Jean-Marie Luginbuhl, North Carolina State University.



Natural Resources Conservation Service

nrcs.usda.gov/



Improvements Needed

- Roof runoff management
- Heavy Use Area
- Hoof Issues – effects on animals



Photo courtesy of boergoatsprofitguide.com

Natural Resources Conservation Service

nrcs.usda.gov/



Overview of Kaitlin Farbotnik's Operation (Shady Fox Farm)

We operate about eighty total acres of hay and pastureland. We raise 100% grass-fed beef, pastured pork, and pastured poultry. Everything we sell is direct to the consumer through farmer's markets and a small CSA program. While we are not certified organic, we do try to farm as "naturally" as possible by limiting the amount of off-farm, commercial inputs.

When we first began rotating our cattle, we used longer rotations of about a week. We decided to tighten that up to only one or two days and quickly realized that with the time commitment and fencing issues were not going to work for our operation. Our main fencing issues related to battling deer damage to multi strand temporary fences, which were required to run our cattle closer together in tighter rotations. We have been rotating our cattle about every three to four days depending on conditions and rely heavily on a monitoring program that consists of monitoring the soil, the height and health of the plants, and the body condition of our animals to make sure we are moving at the appropriate times.

Our pigs, however, are a different story. During the growing season we have achieved good management using annual mixtures and rotational grazing. In the wintertime we still have bare areas and erosion, even though our winter areas are buffered, this is something I would like to control better. We are considering wintering our pigs in the barn to avoid the issue altogether. This will also allow us to capture those nutrients to spread on our hay fields.

Below are some pictures showing the mix we use on the pig pastures (we also supplement with additional clover seed) and the erosion around our over-wintering pig area.



Breakout #1

Tri-State SARE webinar: Creating meaningful soil health change

*If you are a service provider, please fill out this sheet with a farm in mind that you work with routinely, who you know could use your knowledge and assistance in making positive changes to their soil health.

Breakout session 1

1.Circle the soil health principle that needs most improvement in your operation

1. Maximize Soil Cover
2. Minimize Disturbance
3. Maximize Biodiversity
4. Maximize Continuous Living Roots

1a. What made you choose that principle?

1b. How do you plan to work toward making positive change in respect to that principle?

2. What additional areas of concern do you have regarding soil health in your operation?

3. What challenges do you have when it comes to making positive change to your soil health? (think: resources, equipment, labor, soil characteristics etc)

4. List below the soil health practices, if any, you have tried in the past. Of those, what has been the most successful?

Managing the Land Importance of Lime

Managing the pH in pastures and hayfields, especially those that are managed through no-till is very important. These types of soils tend to accumulate acid within the top 2" of the soil. The top 2" of soil is where most of the seed germination occurs. Lime should be applied at smaller intervals, but more frequently, and best timed before a steady rain since rainfall is how the lime will move through the profile.



Importance of Lime

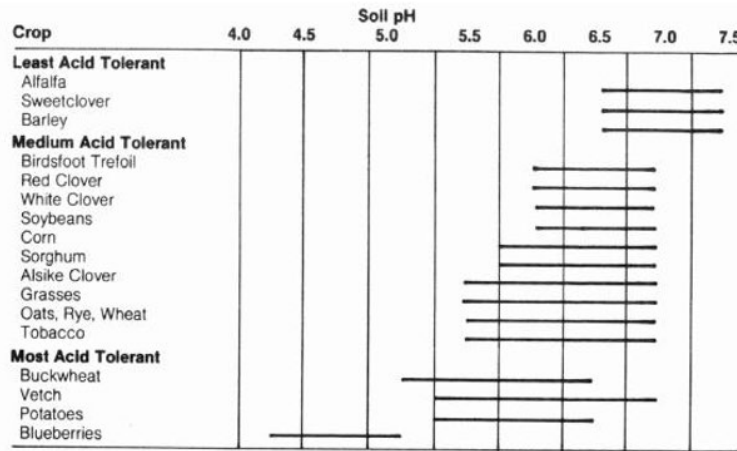

Perdue University: Soil Acidity and Liming of Indiana Soils, AY-267



Natural Resources Conservation Service

nrcs.usda.gov/



How soil pH affects availability of plant nutrients

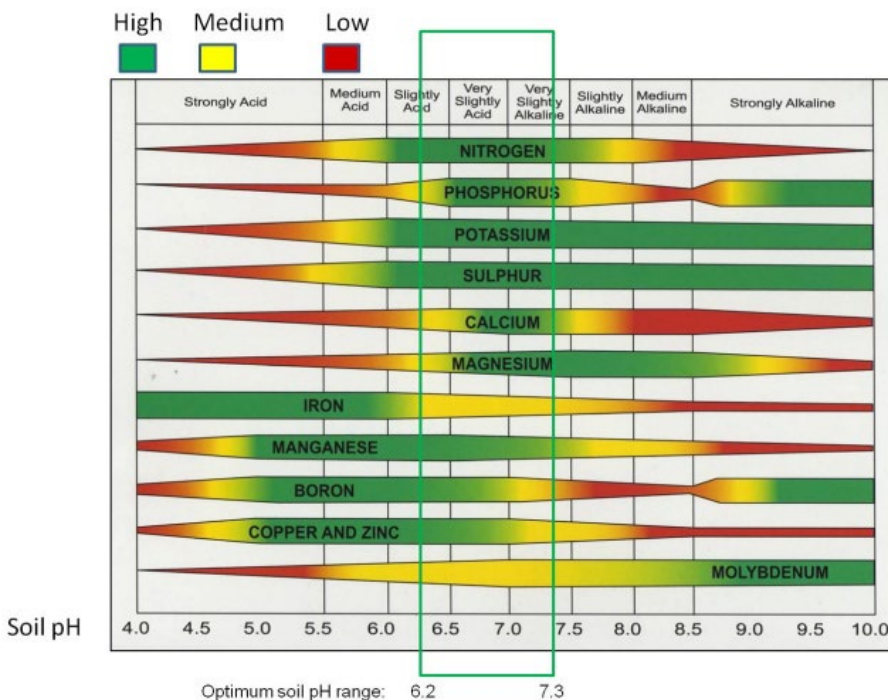

If using annuals and cover crops, spreading lime right before drilling is a good method. The fineness and quality of lime is also important when choosing lime, however, there needs to be a balance between cost and quality. Soil testing is essential for determining your soil pH and required nutrients. Consult with your local extension office if you have questions about your soil fertility or if you need a soil test.

Depending on the kind of forages you are growing, you may need a higher or lower pH. Most commercial forages will do well at a slightly acid level of 6.0

to 6.5. A few forages like alfalfa and barley like a more neutral to basic pH of 7.0 to 7.5. The pH level in your soil is crucial for proper nutrient uptake of the plants. If the pH is too low or too high, it doesn't matter how much nitrogen, potassium, sulfur, etc. you apply to the soil – the plants simply will not be able to take up those nutrients and will not be able to reach their full potential. If fertilizers are applied and not able to be utilized by the plants they can be lost through leaching, volatilization, erosion, and numerous other pathways - meaning you are losing money every time you lose nutrients because of uncorrected pH levels.

Compaction and Bulk Density



Compaction



Pressures Created by Different Stressors

Stressor	Pressure (Psi)
Sheep	12
Human	14
Utility terrain vehicle	14
50-ton bulldozer	16
Cattle	27
Walking Cattle	48
Horse	27
Walking Horse	48
Tractor	175

Studies done in sandy loam soils showed an increased bulk density by 8% when heavily grazed



11 Higgins et al. Revised 2017
Trimble, W.S and A.C. Mendel, 1995

Natural Resources Conservation Service

nrcs.usda.gov/

Compaction in pastures is one of the most common soil health problems that we deal with as agricultural service providers and as farmers. Compaction can occur very quickly in a field and often there are little to no indicators from a visual inspection of the above ground system that compaction is happening, which makes it such a tricky problem to manage.

One of the benefits to using small ruminants in

a grazing system is that they have a much lower impact on the soil since they are smaller in size. You can see a sheep will create about 12 psi of pressure while a cow will create about 27 psi of pressure, on average.

Animal behavior also comes into play when managing compaction. Animals that are constantly moving, like horses will create more compaction because of the hoof action of the walking motion.

Bulk Density

Bulk density is directly related to compaction. It is a quantitative measurement of the soil that explains how much pore space is within a set volume of the soil. Pore spaces are crucial for soil health because

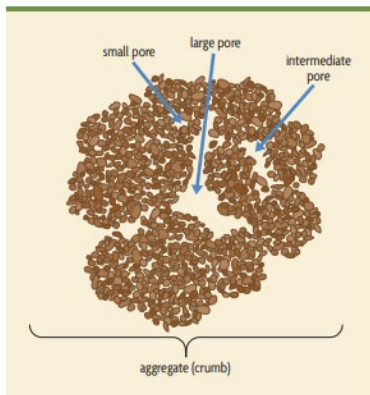

Figure 5.5. A well-aggregated soil has a range of pore sizes. This medium-size soil crumb is made up of many smaller ones. Very large pores occur between the medium-size aggregates.

Soil Texture	Ideal bulk density (g/cm ³)	Marginal bulk density (g/cm ³)	Root restricting bulk density (g/cm ³)
Sands, loamy sands	<1.60	1.69	>1.80
Sandy loams, loams	<1.40	1.63	>1.80
Sandy clay loams, clay loams	<1.40	1.60	>1.75
Silts, silt loams	<1.40	1.60	>1.75
Silt loams, silty clay loams	<1.40	1.55	>1.65
Sandy clays, silty clays, clay loams	<1.10	1.49	>1.58
Clays (>45% clay)	<1.10	1.39	>1.47

Source: USDA-NRCS

they allow for the water, air, the movement of microorganisms, roots, and the movement of nutrients, just to name a few.

Typically, a healthy soil will be made up of about 50% particulate (soil) matter, 25% pore space filled with water, and 25% pore space filled with air. The pore space percentages will fluctuate depending on the type of soil and weather conditions.

One way to think of your soils bulk density and compaction is to compare that soil to a piece of bread. Pretend that you have a fluffy, airy piece of bread in your hand. Now imagine squeezing that bread in your hand into a ball and release. You have just compacted all those air spaces within that piece of bread and made it much denser. This is the same action that overgrazing during wet weather conditions can have on your soils. Your soil can become compacted, dense, and not able to easily recover or “open” back up. All those spaces that once provided areas for water and air exchange, for the movement of nutrients, and habitat for soil organisms and roots have collapsed.

The yellow chart above shows the ideal bulk density for various types of soils. A quantitative measurement of bulk density, and thus compaction, can be done through lab analysis, although this can be costly and take time for collection and testing. There are other ways to determine how compacted your soils are that can be done with minimal tools.

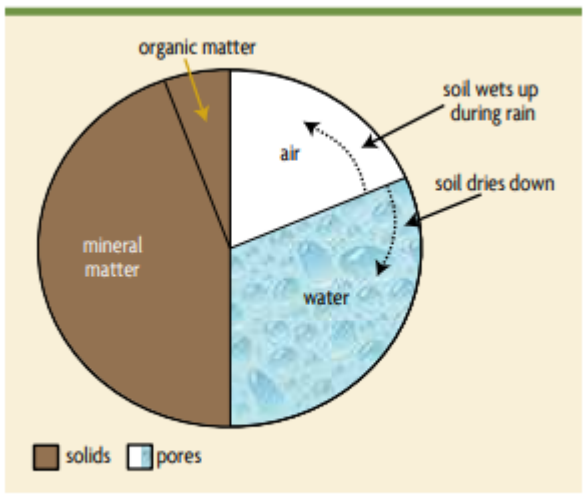
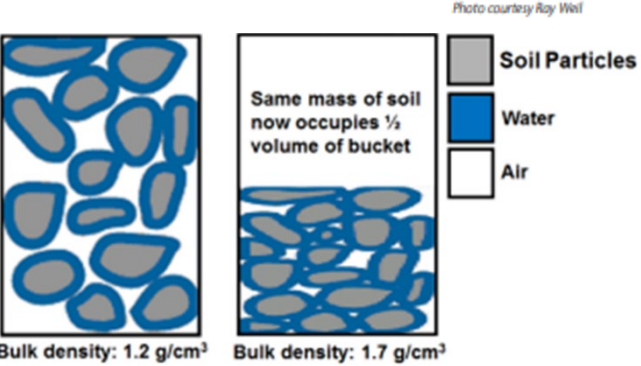

Figure 5.1. Distribution of solids and pores in soil.



Photos: Building Better Soils for Better Crops, 4th Edition And <https://agrosphere-international.net>

Planning to Avoid Pugging

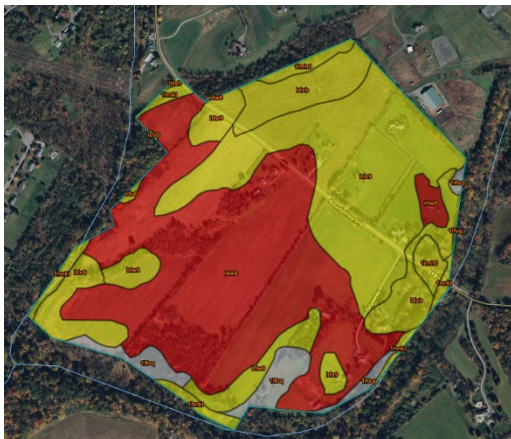
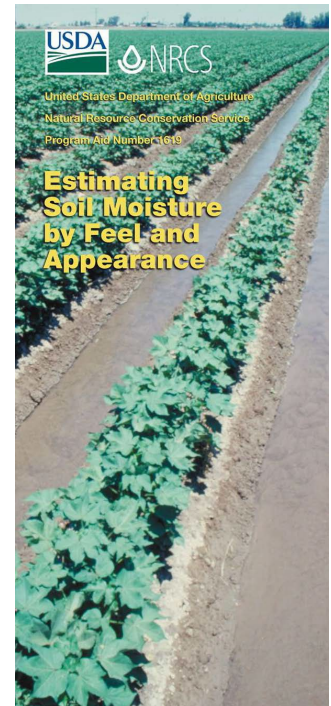

Photo: Sjoerd Duiker

Pugging of the soil is a sure sign that compaction has occurred or is occurring. Remember, compaction can occur deeper than 4" in the soil profile before we start to see signs on the surface. By the time you see pugging in your fields, the damage has already been done and it is time to think about how you are going to mitigate that compaction.

For more information on using soil moisture as an indicator for compaction, see Fact Sheet 1.634 from Colorado State University on the following pages.

There are multiple tools available to use to predict and manage for compaction in your pastures. Checking your soil moisture is important, as noted in the mentioned Fact Sheet. This can be accomplished using mechanical moisture meters, or by using the "Estimating Soil Moisture by Feel and Appearance" guide which can be downloaded as a PDF or ordered for free from the [NRCS Distribution](#). Your local NRCS office may also have copies available.



Example map from the Web Soil Survey showing areas with high (red) and medium (yellow) susceptibility to compaction.

Another invaluable resource is the [Web Soil Survey](#). You can use the Web Soil Survey and the "Soil Susceptibility to Compaction" interpretation to determine where your most at risk pastures are on your property. Knowing this information can help you decide which pastures to avoid during wet times of the year like the spring and the fall.

Monitoring the weather forecast and making at-least daily visual inspections of your pastures will help you determine when your animals need to be moved to avoid compaction problems in the future. Developing a monitoring plan and keeping records is a great way to become familiar with the capabilities of your soils.

Managing Cattle Impacts When Grazing on Wet Soils

Fact Sheet 1.634

Livestock Series | Management

By Casey Shawver, Joe Brummer, Jim Ippolito, Jason Ahola, and Ryan Rhoades*

Grazing and Soil Structure

Soil structure is an important factor that contributes to healthy, functioning soils. The structure of a soil is determined by the way sand, silt, and clay particles are held together in various shapes known as soil aggregates. A soil that has well-formed, stable aggregates will have large pore spaces that allow for air exchange, rapid infiltration of water, and deeply penetrating root systems. When grazing, trampling by cattle can impact soil structure by breaking up aggregates which results in compaction. At some level, compaction is present in most pastures, but can be exacerbated by grazing when soils are wet. In addition, heavy clay soils are more prone to degradation than sandy soils. When wet soils are grazed, surface and subsurface damage can occur due to the effects of pugging (Fig. 1).



Figure 1: Pugging that resulted from grazing during wet conditions post-precipitation.

Pugging breaks up aggregates and causes damage to large soil pores which increases bulk density, resulting in

compaction. These soil physical property changes can reduce water and air movement into and through soils, and can impede root growth which results in reduced drought tolerance and pasture yields (5).

Rate of soil degradation depends on soil type, plant litter accumulation, and soil moisture (2, 3, 4), as well as stocking density (i.e., animals per unit area) and grazing duration. Multiple management strategies exist that can be used as tools to mitigate damage to soil when grazing (Table 2). Their use is especially important when employing various grazing systems where animals are concentrated at high stock densities (e.g., short duration grazing, high intensity-low frequency grazing, management-intensive grazing (MiG), and mob grazing).

Managing Trampling on Wet Soil

Trampling on moderately wet soil causes soil remodeling around animal's hooves, resulting in pugging (Fig. 1). The visible indentations caused by pugging generally affect the top 2 inches of soil and can cause direct damage to

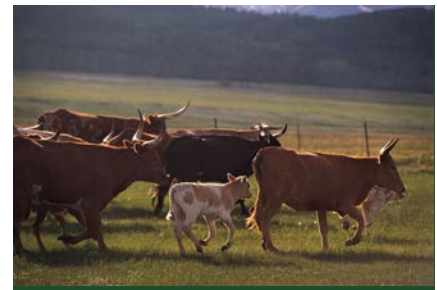

Quick Facts

- Soil physical damage can occur when grazing through pugging and compaction, especially when soils are wet.
- Removing cattle early in a precipitation event can minimize the most detrimental impacts from grazing on wet soils.
- Remediation of pasture soils from compaction using mechanical methods has shown variable results.
- Cattle management, soil monitoring, and contingency plans can be used to mitigate negative impacts to soil.

*Casey Shawver, Former Graduate Student, Joe Brummer, Associate Professor-Forage Extension Specialist, and Jim Ippolito, Associate Professor-Soil Fertility and Environmental Soil Quality, Department of Soil and Crop Sciences; Jason Ahola, Professor-Beef Production Systems, and Ryan Rhoades, Associate Professor-Beef Extension Specialist, Department of Animal Sciences

to plant crowns (4). When soils become pugged, the indentations along with reduced water infiltration result in water capture and puddling on the surface which saturates the soil and makes it susceptible to severe pugging damage (Fig. 2) and potential compaction at greater depths (6, 8).

While pugging has direct impacts on soils and vegetation, compaction is considered to be an indirect response to that damage. Current research on mechanical compaction remediation (e.g., aeration, deep ripping, etc.) methods shows varied results with little success in irrigated perennial pasture systems. Without many remediation options for soil compaction besides time and natural processes, strategies to avoid or mitigate negative impacts should be a priority.



Figure 2: Saturated soils lead to severe pugging after a heavy precipitation event.

Soil water content and soil texture are the most important factors affecting compaction severity. When wet, soils have little structural integrity allowing

cattle hooves to cause direct damage to the soil surface and pasture plants. Soil compaction begins to occur as the moisture content of a given soil approaches the plastic limit up until it reaches field capacity. After that point, the soil reaches its liquid limit and the soil compaction risk becomes low but the pugging risk and direct damage to plant crowns remains very high. Field capacity relates to the amount of water a soil can hold after being thoroughly wetted and allowed to drain for 2 to 3 days. A soil at field capacity is wet and will form a soft ball that exudes water on the surface when squeezed (9).

For more information on visually determining soil

moisture, see the NRCS document [Estimating Soil Moisture by Feel and Appearance](#). The plastic limit refers to the moisture content at which a soil can be rolled into a thread and the thread begins to break apart or crumble at a diameter of about 1/8 inch. Soil compaction damage is not always visible at the surface and can occur at considerable soil depth (greater than 4 inches). Soil trampling should generally be avoided near and beyond the soil plastic limit (7) (Table 1). Pugging and compaction can both occur when a soil is at or beyond the plastic limit, especially when grazing on clay textured soils.

Table 1. Plastic limit and field capacity soil moisture percentages for various soil texture classifications.

Soil Texture	Plastic Limit (%)	Field Capacity (%)
Loam	20	25
Silt Loam	21	29
Silty Clay Loam	24	33
Clay Loam	27	35
Clay	28	35

Table 1 lists corresponding soil moisture levels for the plastic limit and field capacity associated with various soil textures. The soil texture(s) in your particular pasture can be obtained from a soil test or the [NRCS Web Soil Survey website](#). Once you have determined the dominant soil texture(s) in your pasture, a soil moisture meter can be used to help monitor and manage grazing decisions. Numerous companies sell digital meters that measure soil water content (Fig. 3).



Figure 3: Spectrum technologies Field Scout TDR 150 and Extech MO750 moisture meters

These meters can be used to take quick in-field measurements. Because of in-field variability, it is important to take a minimum of ten random measurements within each major soil type/texture in your pasture and calculate an average soil moisture for each one. It is not necessary to have a moisture meter with long probes (3 to 4 inches is ideal) because surface moisture is generally of greatest concern when grazing.

In our experience on an irrigated pasture with a Nunn clay loam soil with close to 40% clay content, the soil moisture value of concern was somewhere between the plastic limit (~27%) and field capacity (~35%). Based on numerous measurements with a soil moisture probe following heavy precipitation events or irrigation, the value that corresponded with significant visual pugging was 30% or greater moisture content. Minor pugging occurred at soil moisture levels between 27 and 30%. Based on these observations, subtracting about 5 percentage points from the field capacity moisture percentage for your given soil(s) (see Table 1) would be a good starting point to identify a damage threshold. Keep in mind that this is only a starting point and must be combined with visual assessments for your particular pasture. Once you get a good feel for a damage threshold percentage that works in your pasture, you can reliably use the soil moisture meter to make decisions.

Most detrimental effects on soil physical properties occur with initial trampling. Removal of stock from pasture during or shortly after heavy rainfall can significantly reduce trampling damage. One strategy is to move cattle to a designated sacrifice area, or to a pasture with sandy soil types where drainage is more rapid.

Another strategy is to significantly lower stocking density (i.e., animals per unit area), which spreads cattle across a larger area of land to minimize impacts in one particular area (1).

Figure 4: Severe pugging that occurred due to pacing along the fence line in anticipation of moving to a new paddock.



Moving cattle to new paddocks more frequently reduces the amount of time spent on one area and helps avoid pacing along fence lines that occurs when forage levels begin to decline (Fig. 4). Also, as available forage begins to decline, more soil is exposed allowing greater pugging to occur. Older stands in which the plants have grown together to form a sod or ones that simply have more surface residue present will help to mitigate this issue.

There are numerous variables to consider when making decisions to protect soil and pasture health when grazing. These variables include:

- Amount of recent precipitation and/or irrigation (i.e., cumulative soil moisture)
- Temperature, wind, humidity, and cloud cover (i.e., are conditions adequate for drying)
- Future weather conditions (i.e., is more rain and/or poor drying conditions forecast for the next 3 to 5 days)

With these variables in mind combined with a visual assessment of the degree of pugging occurring and soil moisture levels (if available), the following guidelines can be used to make management decisions (Table 2).

Table 2. Decision making using visual assessment of pugging and soil moisture levels.

Visual and soil moisture assessment	Management approach
Little to no visible pugging, moisture levels below plastic limit for your soil(s), no precipitation in the near-term forecast, and weather favors drying	Continue grazing as normal
Pugging < 1”, soil moisture levels at to slightly above plastic limit for your soil(s), no precipitation in the near-term forecast, and weather that favors drying	Options include: Giving cattle double the amount of normal space to graze, moving to a pasture with coarser textured soil, moving more frequently, or moving to a sacrifice pasture
Pugging ≥ 1”, soil moisture levels about 5 percentage points below field capacity or higher for your soil(s), forecast calls for continuing precipitation or inadequate drying conditions	Options include: Moving cattle to a sacrifice pasture (if forage supply becomes inadequate, consider feeding hay) or removing cattle from pasture and into a drylot (if this is an option)

References:

1. Bilotta, G.S., Brazier, R.E., Haygarth, P.M., 2007. The impacts of grazing animals on the quality of soils, vegetation, and surface waters in intensively managed grasslands. *Adv. Agron.*
2. Chanasyk, D.S., Naeth, M.A., 1995. Grazing impacts on bulk density and soil strength in the foothills fescue grasslands of Alberta, Canada. *Can. J. Soil Sci.* 75, 551–557.
3. Chiavegato, M.B., Rowntree, J.E., Powers, W.J., 2015. Carbon flux assessment in cow-calf grazing systems. *J. Anim. Sci.* 93, 4189–4199.
4. Drewry, J.J., Cameron, K.C., Buchan, G.D., 2008. Pasture yield and soil physical property responses to soil compaction from treading and grazing - A review. *Aust. J. Soil Res.* 46, 237.
5. Greenwood, K.L., McKenzie, B.M., 2001. Grazing effects on soil physical properties and the consequences for pastures: A review. *Aust. J. Exp. Agric.* 41, 1231–1250.
6. Horne D.J., 1992. Some effects of treading damage by dairy cows. In 'Proceedings of the 6th National Land Drainage Seminar.' Whakatane, New Zealand. (Eds DJ Horne, IFH Furkert) pp. 55-64. (Massey University; Palmerston North, NZ)
7. Mapfumo E., Chanasyk D.S., Naeth M.A., Baron V.S., 1998. Forage growth and yield components as influenced by subsurface compaction. *Agron. J.* 90, 805-812.
8. Scholefield D., 1986. The fast consolidation of grassland topsoil. *Soil Till. Res.* 6, 203-210.
9. USDA-NRCS, 1998. Estimating soil moisture by feel and appearance.
Retrieved from: https://www.nrcs.usda.gov/Internet/FSE_DOCUMENTS/nrcs144p2_051845.pdf.



Overview of Grazing, Compaction, Bulk Density, and Soil Moisture

Moist soil will compact easier, potentially increasing bulk density



Increased bulk density means less pore space



Less pore space means less room for water, roots, and air



Less room for water, roots, and air = dead plants and microbial life



Plan and monitor to prevent compaction to maintain soil health (productivity)

Natural

Managing the Plants

Benefits of Multi-Species Forages

Including multiple types of forages in a system, perennial or annual provides many soil health benefits. While we can see some of these benefits on the surface of the soil, most of the benefits are gained below ground.

Looking at the picture to the right, imagine we were going to plant a diverse mix of species like red clover, plantain, chicory, ryegrass, and fescue.

Take note of the root systems on those plants and the above ground structure of those plants. Just some of the benefits of that mix include:

- Multiple functional groups which include grasses, forbs, and legumes.
- Tap root species to help break up compaction
- Shallow fibrous root systems that will help stabilize topsoil
- Deep fibrous root systems that will help with mid-layer compaction and will help stabilize soil
- Plants that have anti-parasitic properties for small ruminants
- Species that have the ability to provide nitrogen for our system, if managed properly
- Multiple plant species that will provide habitat for different microorganisms, increasing the belowground diversity
- Increased resiliency in our system in terms of drought or disease
- Increase utilization, or opportunity, for grazing multiple species (sheep, goats, cattle, etc.)

If you have identified a soil health concern in your pastures, think about which plant species you can use to help mitigate for that concern. Do you have any compaction? Ponding? Low organic matter? Low fertility? Different forage species can help mitigate a myriad of problems that we see in pastures!

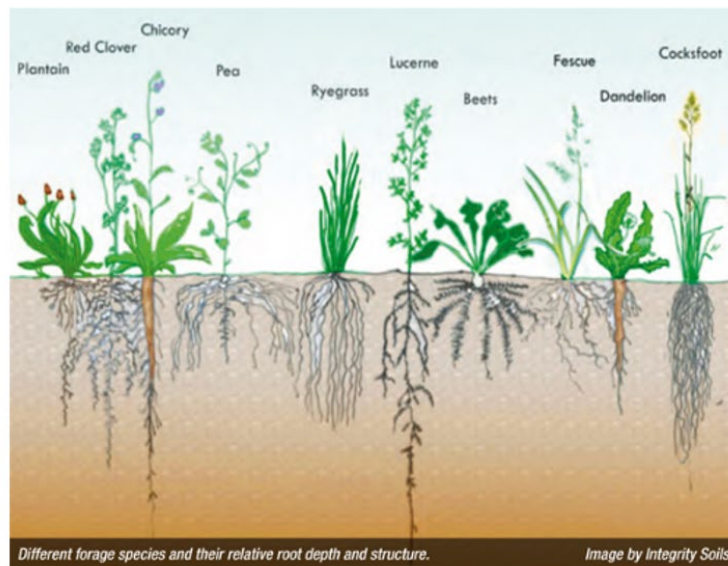
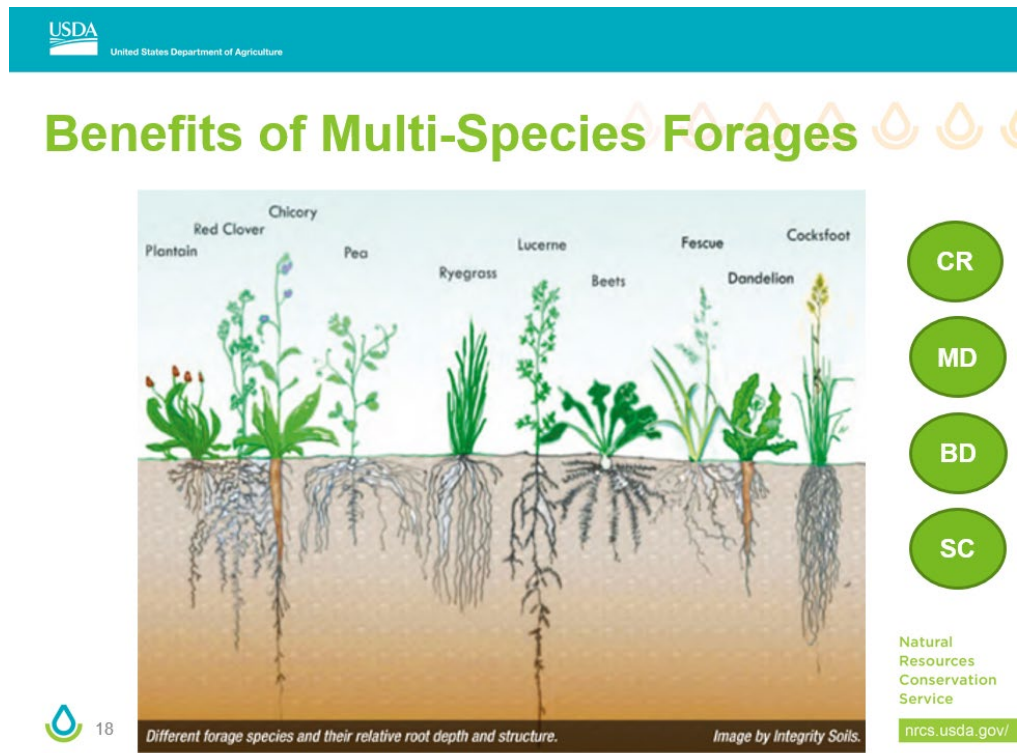

Natural Resources Conservation Service
nrcs.usda.gov/

Diversity in Growing Seasons

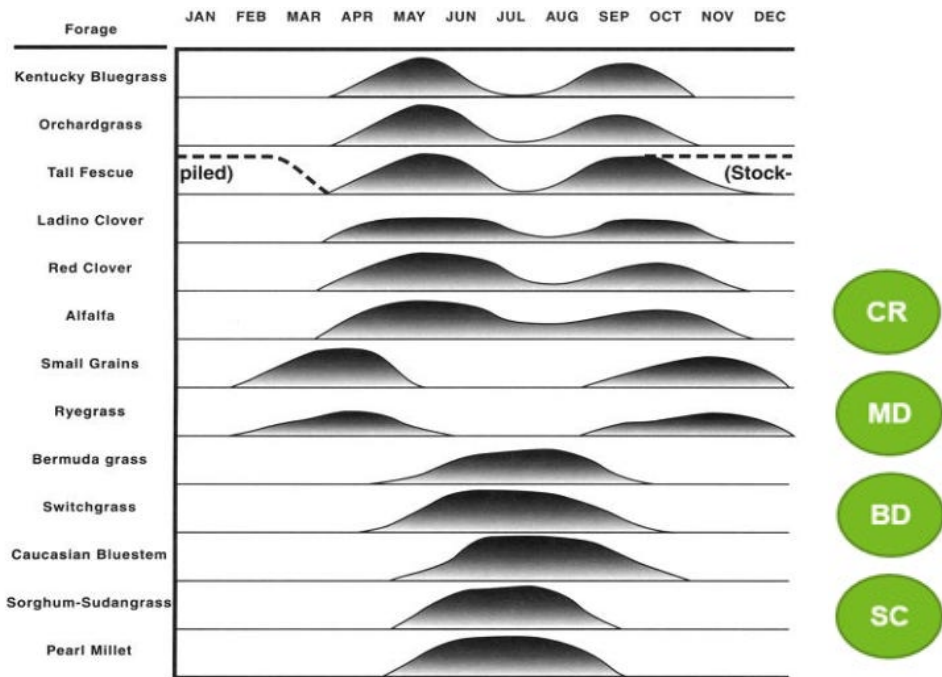

University of Vermont

Diversity is also in your growing seasons.

Diversifying your forages will allow you to extend your grazing season and provide additional forage during traditionally less productive times, like the summer grazing slump. Diversifying your growing seasons can be hard to do in an existing perennial system, although with some careful planning it is possible.

Soil Health Lessons with Winter and Summer Annuals (Shady Fox Farm)

Winter Annuals

Annuals are an important part of our rotational system because they allow us to regenerate our fields, add biodiversity, and correct any compaction that occurred throughout the previous years of grazing. We typically replant our perennials about every eight years with two to three years of annuals in between the perennial periods. In the wintertime a mix we like to use is an oat, ryegrass, and cereal rye mix. The oats will give us quick cover in the fall for grazing and the ryegrass and the cereal rye will overwinter giving us good early spring grazing. Sometimes though, not everything goes as planned. Below on the left and middle are pictures of a successful fall planting where we grazed multiple times in the fall of 2020 and in the spring on 2021 (cows were taken off until grass was tall enough). On the right was the spring of 2022. We were not able to get our mix planted in the fall and had to settle on a spring planting, leaving the soil uncovered all winter long.



Summer Annuals



When we first started working annuals into our system, we played around with many different types of summer annuals. We tried all the different “crazy mixes.” What we found was that, for us, simpler was better. For our herd the more elaborate mixes were more expensive, but our animals didn’t eat any of the species that made those mixes expensive, so we had less utilization of these mixes with more expense. We also found that the taller mixes created a lot of anxiety in our herd because our cows and calves would get separated and the pairs were constantly calling back and forth – noisy cows made for

nervous farmers and upset neighbors. After some trial and error, we settled on a mix of cowpea and millet which grows very well in our summer heat, provides lots of good forage, increases the diversity in the ground, and leaves a good amount of residue.

Utilization Rate

Grazers have good spatial memories - they can remember where they chomped down on tasty, nutritious forages. If animals are allowed access to the same area for a longer period, typically 5-14 days depending on weather, they will go back and eat from the same plant they previously grazed. This depletes that individual plant’s root reserves and leaves other

forages available for grazing untouched in the pastures, resulting in uneven utilization. The longer the occupation period in the pasture, the more uneven grazing (or utilization) will occur.

Grazing at the Proper Utilization

WHY DOES THE UTILIZATION RATE ↓ WHEN THE LENGTH OF OCCUPATION INCREASES?

Length of Occupation (days)	Utilization Rate (%)
1 or less	80
2 – 3	75
4	70
5	65
6	60
7	50
14	40
Continuous – low stocking density	35
Continuous – high stocking density (overgrazed)	90

22

CR

MD

BD

SC

Natural Resources Conservation Service
nrcs.usda.gov/

Understanding Stocking Density



United States Department of Agriculture

Understanding Stocking Density

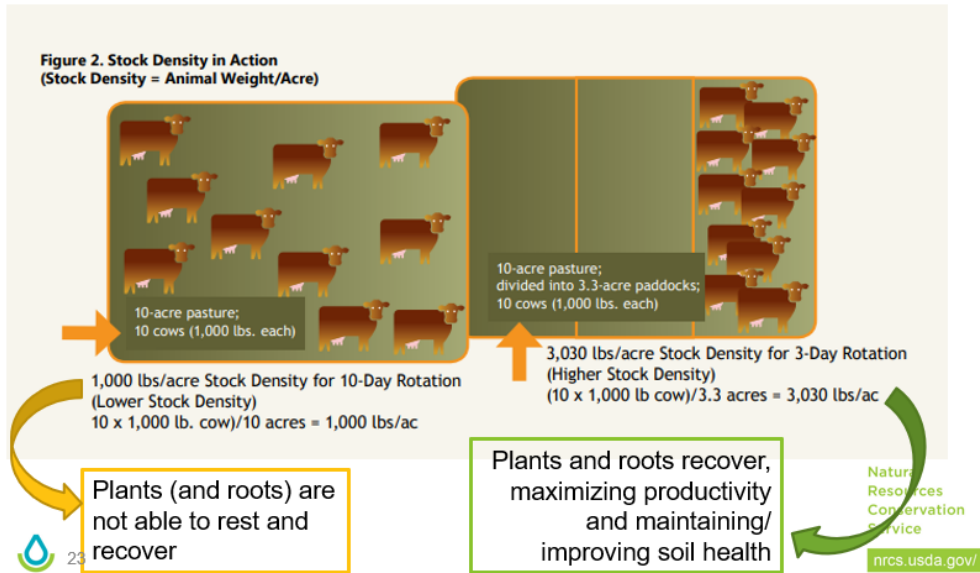

Nutrient Distribution of Managed Grazing Land



United States Department of Agriculture

Nutrient Distribution of Managed Grazing



Evenly distribute manure across a pasture



75-90% of nutrients from manure are redistributed in the pasture. Even distribution = even grazing.

Number of Paddocks	Rotation Frequency	Years to get 1 pile/sq. yard
1	Continuous	27
3	14-day	8
12	4-day	4-5
24	2-day	2



Source: Lory, J. and R. Kallenbach. 2002. Managing nutrients in a grazing system. Univ. of Missouri

Natural Resources Conservation Service

nrcs.usda.gov/

Nutrient management is an integral part of any soil health system because an over or under fertilized field will affect soil health properties.

There is an overarching goal in grazing nutrient management that you want to achieve one patty per sq. yd. in the pasture. The more you rotate your animals, and adjust pasture size appropriately, the closer you will come to meeting this goal.

Root Response to Grazing

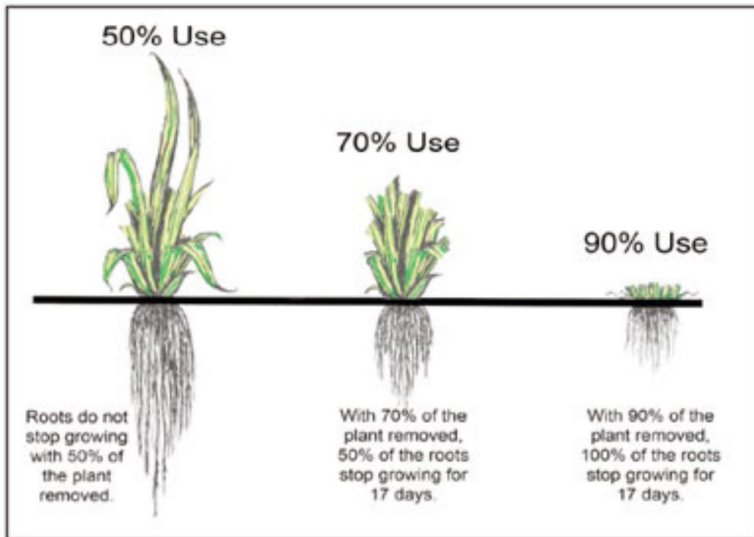
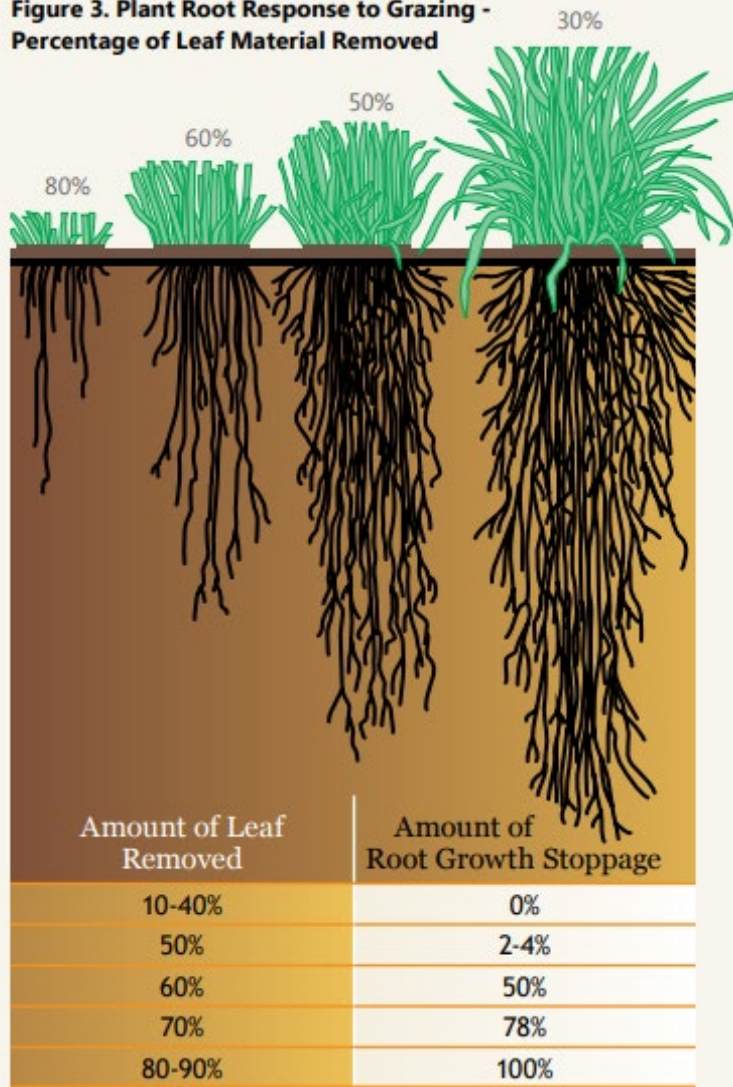

Figure 3. Plant Root Response to Grazing - Percentage of Leaf Material Removed



Remember those utilization rates and how an animal will re-graze the same plant over and over if given the opportunity? This is important to remember because the more the plant is eaten from the top, the more the roots will be depleted below the surface.

Those roots are vital for multiple reasons including:

- Maintaining and improving the pore spaces in the soil – allowing for water, air, and nutrient exchange.
- The roots provide structure to the soil, helping to stabilize the soil and prevent erosion and compaction
- Roots are also constantly dying and regrowing. Every time a root sloughs off it provides additional food for microorganisms and nutrients to the plant when they decompose.

Since we can't go around digging up every plant in our fields to determine how healthy our roots are, a good rule of thumb is the "take half, leave half" notion. The idea that taking only half the above ground biomass of a plant allows a balance of forage intake and below ground root production is backed by numerous studies. This isn't always as simple height measurement however, but monitoring using a fall plate meter can help you hone in on where your "half" biomass falls. See the factsheet from West Virginia University Extension on the next pages from more information on how to make your own falling plate meter.

Top Photo Source: OnPasture.com

Bottom Photo Source: Crider, F. J., 1955, Root Growth Stoppage, Technical Bulletin No. 1102, USDASCS, Government Printing Office, Washington D.C. Graphic adapted by A. Miller, Black Dog Graphics, from Grass: The Stockman's Crop by H. E. Deitz.

A Falling Plate Meter for Estimating Pasture Forage Mass

Ed Rayburn, *WVU Extension Forage Agronomist*
John Lozier, *WVU Research Assistant III*

Nov. 2003

Background

It is often helpful to have a reliable estimate of forage on offer to grazing livestock. Research has shown that there is a high correlation between forage height and dry matter yield. This correlation is improved when bulk height is determined by depressing the forage with a weighted plate. This weight plate technique referred to as a weighted disk meter, appears to improve the estimate of pasture yield. Different designs of weighted disk meters are called rising plate meters and falling plate meters depending on how measurements are taken. The weighted disk meter described here is a falling plate meter.

Weighted disk meters are generally made of sheet metal using an etched metal measuring rod. Researchers have used modifications of this design to establish the effect of size and area weight on the performance of these meters. Based on this research, an inexpensive weighted disk meter was made from acrylic plastic for use in conducting on-farm research and demonstration programs.

Material

The material needed for a practical pasture plate has to meet the following requirements: it must be readily available in standard stock across the region, it must be stable in weight per unit area when exposed to moisture in the air and on the forage, and it must be relatively inexpensive. Acrylic plastic sheeting meets all these requirements.

A square of acrylic plastic measuring 0.22 inches thick and 18 inches square was chosen. This thickness has a weight per area (1.47 lb./sq. ft.) that results in good prediction of dry matter yield and is inexpensive. The cost of the 18-inch plate was about \$15 (2002). When used with a yardstick, this makes an inexpensive and serviceable falling plate meter for estimating forage yields.

Construction

The falling plate meter is made from 0.22-inch acrylic plastic sheeting cut in an 18-inch square. A 1.5-inch hole is cut in the center of the plate. A yardstick is used for measuring the plate's height above the ground when it is set on the sward. The edges of the center hole need to be smoothed with a wood rasp to prevent rough edges from catching on the yardstick.

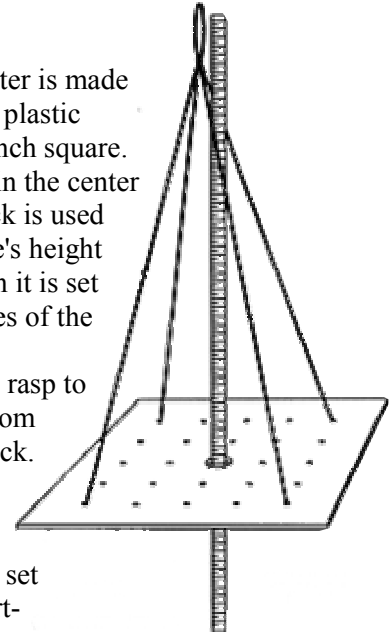

In addition 24, 0.125-inch holes are drilled along five lines set at 3-inch intervals, starting 3 inches from the plate's edge. Holes are spaced at 3-inch intervals along these lines, again starting 3 inches from the edge. This results in 24 holes (the 25th hole being in the yardstick hole). These holes can be used for estimating ground covered in thin stands and in grazed stubble.

The yardstick should be connected to the plate so that the two can be carried as one unit. One way to do this is to tie a string through two or four of the small holes in the plate. Tie a loop at the top of the string, and hold the loop in the hand that is holding the yardstick. The user then places the tip of the yardstick on the ground and lowers the plate gently to the surface of the forage canopy. [Click here for construction details.](#)

Use

Use the plate meter by walking the pasture, selecting a location at random, and placing the plate gently on the forage until it supports the plate. Measure the height of the plate's top above the ground. Placing the plate on the forage is more satisfactory than dropping

the plate from a standard height. We found that dropping the plate is not practical on hills or on windy days.

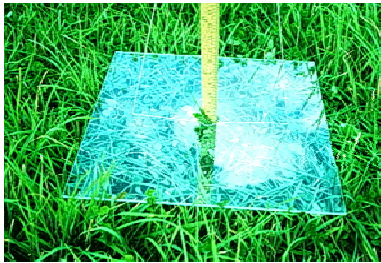

Figure 1. The plate meter and yardstick using a looped string so that the plate and yardstick can be held in one hand. ([Click here for enlarged view](#)).

To achieve a good estimate of the forage mass in a pasture, you must measure enough points. The reliability of the mean pasture height increases as the number of samples increases to 20 or 30, with a little improvement as the sample size increases to 50. Our recommendation is to take at least 30 bulk height measurements per pasture.

When selecting the sample location the user should be careful not to bias the average by choosing more productive areas over less productive areas. Sample to get a representative sample over the pasture. When the general area is reached, the sample point should be taken at random. If the sample point has old seed heads or large weeds, which will bias the plate height, move the plate to one side to miss the obstruction. When used in well-managed, rotationally-grazed or clipped pastures this is not a major problem.

Calibration

Calibration equations for the pasture plate may vary due to species, season, and location. For calibration we use a square wire frame that just fits over the pasture plate. The frame is set over the sample site and the plate removed. The forage is then separated so that the frame lies on the ground. The forage is cut as close to ground level as possible with battery-powered lawn edgers. The forage is weighed wet in the field using lightweight spring scales and composited for dry matter determination. Regression equations are calculated from the measured bulk height and dry matter yield using a scientific calculator.

An alternative to calibration is to calculate the forage density at each sample point by dividing dry forage mass (lb/a) by the plate height of the sample. Density is then lbs dry matter/acre/inch plate Ht. Then average these densities for all the paired clipped samplings.

Testing

The pasture plate has been used extensively in pasture sampling from 1986 through 2003 on cool-season grass-legume pastures managed under intensive rotational grazing. These pastures include orchard grass, timothy, quackgrass, bluegrass, ryegrass, white clover, and red clover stands. An average calibration for estimating dry matter yield (DMY) from pasture plate height was found to be:

$$\text{DMY lb./a} = 432 \text{ Plate Height (inches)}$$

The fact sheet “Estimating Pasture Forage Mass from Pasture Height” gives more details on general calibrations for use with the falling plate meter, a commercial rising plate meter and ruler measurements of pasture height.

This falling plate meter has been used by farmers over the Northeast as part of the Northeast Dairy Farm Forage Demonstration (a NESARE Project) and as part of other collaborative regional research projects. This plate is as reliable as the more sophisticated metal weight disks meters or expensive electronic probes and provides a practical, low-cost means of extending research recommendations to farmers.

References

1. Bransby, D.I., A.G. Matches and G.F. Krause. 1977. *Disk meter for rapid estimation of herbage yield in grazing trials*. *Agronomy Journal*. 69:393-396.
2. Griggs, T.C. and W.C. Stringer. 1988. *Prediction of alfalfa herbage mass using sward height, ground cover and disk technique*. *Agronomy Journal*. 80:204-208.
3. Michalk, D.L. and P.K. Herbert. 1977. *Assessment of four techniques for estimating yield on dryland pastures*. *Agronomy Journal*. 69:864-868.
4. Varth, E.W. and A.G. Matches. 1977. *Use of a weighted-disk measure as an aid in sampling the herbage yield on tall fescue pastures grazed by cattle*. *Agronomy Journal*. 69:888-890.

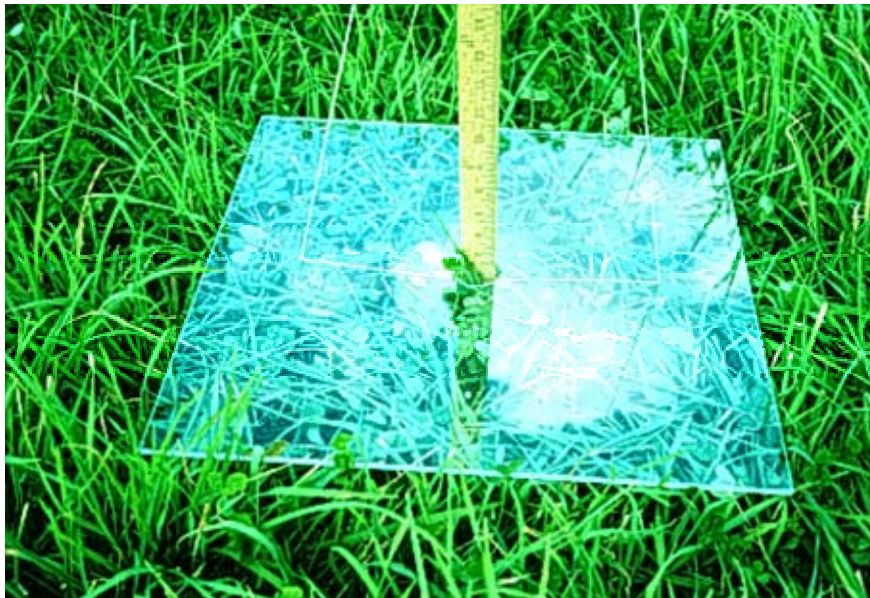
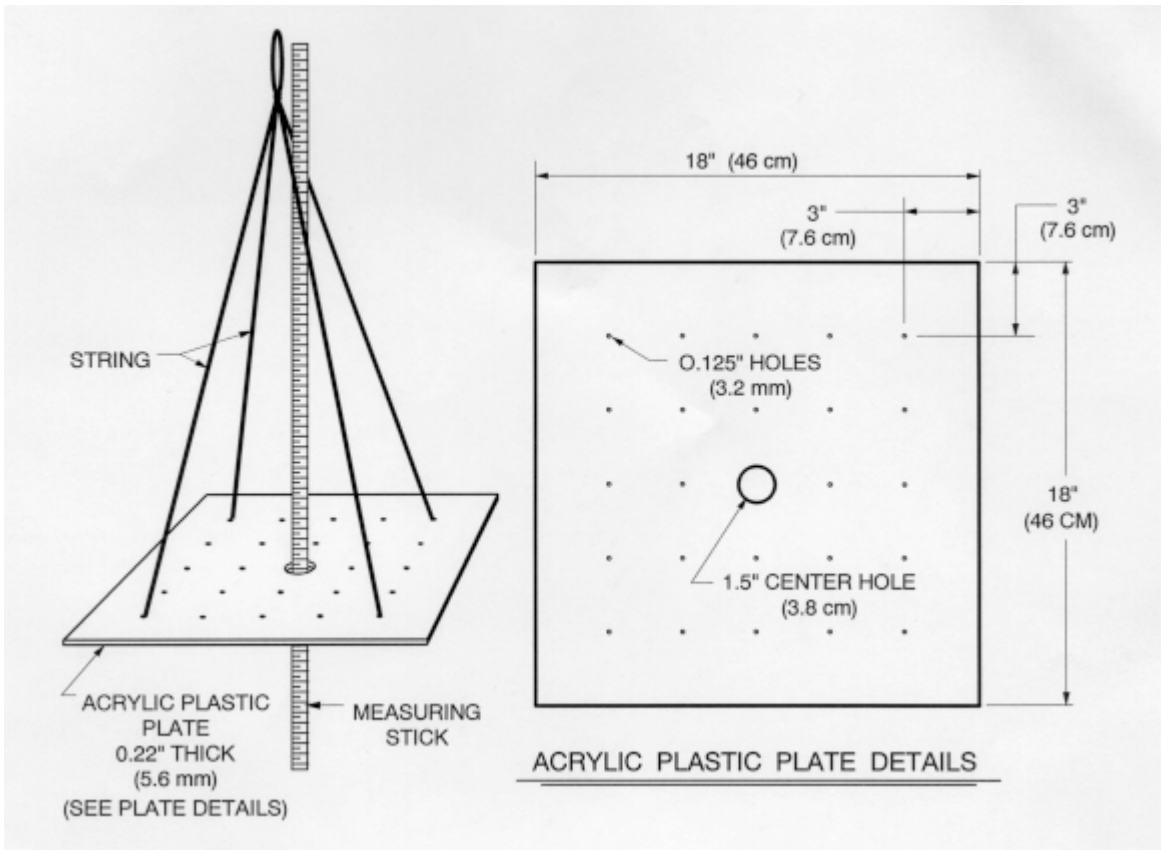

Lesson's About Customizing Plant Heights for Small Ruminants (Matthew Denton)

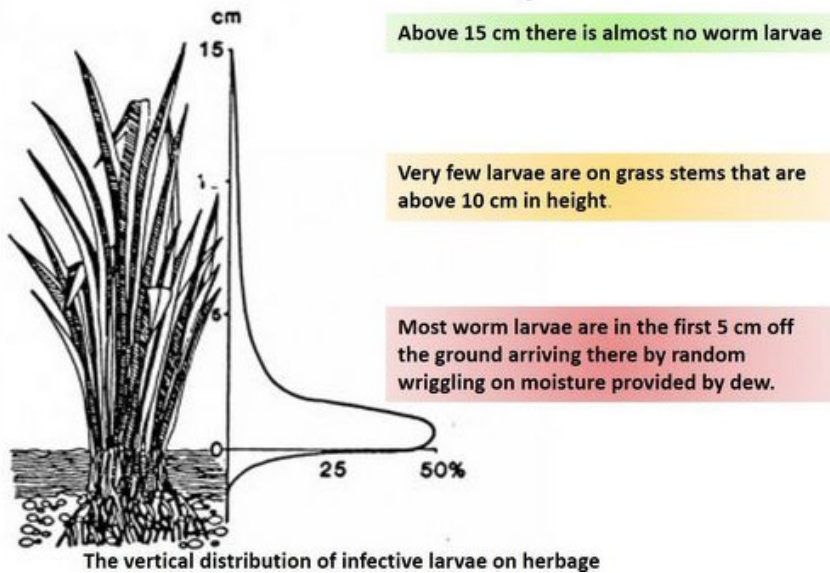

Sources: Dr. Sandra Baxendell;
Vlassoff 1982

I have noticeable fewer parasite issues if I do three items pertaining to soil and animal health management as a systems approach:

1. Diversify plant species and especially focus on taller species (cereals and tall grasses)
2. Rotation – moving animals every 30 days or less to stay ahead of the parasite growth cycles
3. Small ruminants have access to quality Serica Lespedeza hay (& free choice minerals)

Helpful Links to Small Ruminant Information

[Sustainable-Control-of-Internal-Parasites-in-Small-Ruminant1.pdf \(wisc.edu\)](#)

[URIWorkToImproveParasiteControlSheepGoat.pdf \(cornell.edu\)](#)

Managing the Animals

Diversity throughout agriculture is a good thing

Grazing systems that only utilize one species, such as cattle, leave additional grazing opportunities on the table.

NDSU Dickinson Research Extension Center



Benefits of Multi-Species Grazers

Plant	Horse	Cattle	Sheep	Goat
Grass	90	70	60	20
Weed	4	20	30	20
Browse	6	10	10	60

Grazing Preferences by Species:
 Horse grass
 Cattle grass > legumes
 Sheeplegumes > forbs = grass
 Goatforbs > grass > legumes
 Deer..... forbs > grass

31 Source: Joel Poore, Pastureland Ecology, 2018

Domestic Grazers - Diets of Grass, Forb, and Browse

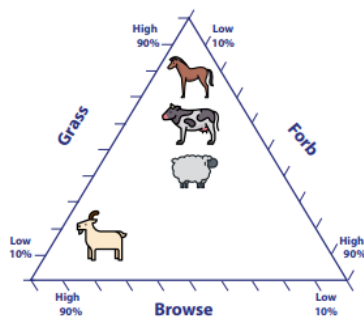

- CR
- MD
- BD
- SC

Natural Resources Conservation Service

nrcs.usda.gov/

Different grazers prefer different types of forages. Maintaining a diverse mix of forages not only provides all of the previously mentioned soil health benefits, but it also provides an opportunity to diversify the kinds of livestock on the operation. If you have a diverse forage base, grazing different types of animals will also increase the utilization of your pastures.

Dung Beetles and Soil Health

Dung beetles are often overlooked in soil health systems, but they play important roles in pasture systems because they:

- Recycle nutrients by breaking up manure into smaller, more reactive pieces
- Help to mix manures in the soil without tillage
- Speed up the decomposition process of manures, leaving less areas with fecal matter

- CR
- MD
- BD
- SC

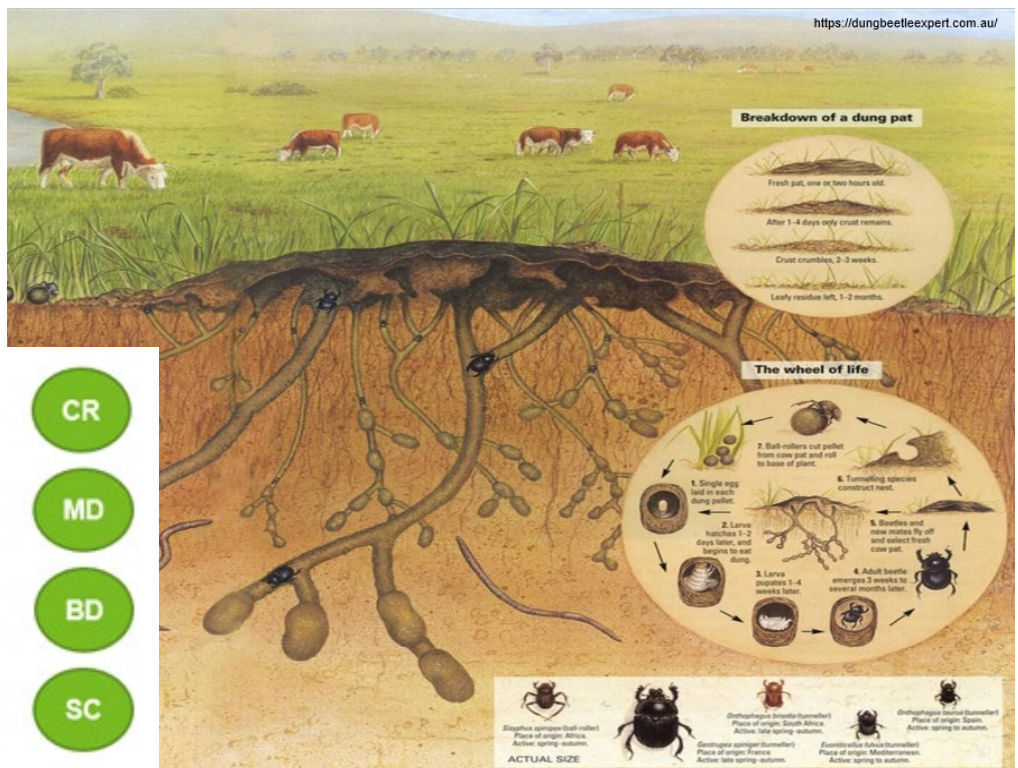

on the surface which means less areas of refuse in the pastures.

- Control livestock pests

There are three main types of dung beetles: tunnelers, dwellers, and rollers.

1. Tunnelers: these beetles thrive below the surface and can tunnel up to 18” into the ground. These beetles will bring manures down into the depths of their tunnels, helping to integrate organic matter and nutrients into the soil profile where deeper rooted forages are able to utilize the nutrients. Those tunnels also make great macropores!
2. Dwellers: these beetles live right at the bottom of pile – top of ground interface. They spend a lot of their time shredding and breaking up the patty from the inside. They help to break the manure up into smaller, more reactive pieces.
3. Rollers: you’ve probably seen these beetles in videos before. Rollers will take a chunk of manure and roll the piece away from the pile, helping to disperse nutrients further out in the field.

If dung beetles are something you would like to increase in your fields there are some management techniques you can use. Switching from a less intensive rotation to a more intensive rotation will help. Remember the piles/sq. yd. chart from earlier in the presentation? The closer the manure piles are to one another, the easier it will be for dung beetles to thrive because they will not have to move as far to get from pile to pile. Considering dung beetles are able to eat and drink solely on dung, having their buffet closer together will encourage a higher dung beetle population.

Chemical	Common Names	Likelihood of Beetle Toxicity
*This table is for informational purposes only; NRCS does not endorse the use (or non-use) of specific pesticides		
Abamectin	Avomec, Cattlegard, Duotin, Genesis, Paramectin, Virbamec, Endomec	High
Doramectin	Dectomax	High
Eprinomectin	Eprinex, Longrange, Broadline	High
Ivermectin	Baymec, Bomectin, Cevomec, Ecomectin, Genesis, Ivomec, Noromectin, Virbac	High
Moxidectin	Cydectin	Unlikely
Source: Consider Your Dung Beetles when Using Parasiticides (http://www.dungbeetle.com.au/considerbeetles.pdf), parastipedia.net, and Dr. Shaun Forgie (https://dungbeetles.co.nz/establishing-dung-beetles-and-using-chemicals-for-internal-external-control-of-livestock-pests/)		

Another very important factor is the method of internal parasite control used in your herd if you use commercial controls. Many of the popular dewormers available in the USA will likely kill dung beetles. However, there are some that are considered to be “dung beetle” friendly. These could be used when dung beetles are the most active, in the spring through fall, while other dewormers can be used in the winter when dung

beetles are not as active. Consult with your local extension office for more information about dung beetle friendly, or unfriendly dewormers.

Overwintering Solutions to Maintain Soil Health

Dry Lots

For operations without sufficient barns or concrete overwintering areas, dry lots – also called sacrifice areas - are affordable solutions that provide a place for livestock to stay during times when pastures need to be rested. These areas can be utilized anytime animals need to be removed from the fields – in the winter, spring, summer, or fall when conditions are not conducive for grazing or when forages need more resting time to achieve proper heights before grazing resumes.

Not only do dry lots save your pastures from overgrazing, compaction, erosion and other detrimental impacts, but dry lots can also improve animal health and performance. For dry lots to be effective, they need to be properly sited and designed. When planning your dry lot think about the following:

- Where on your farm are the “high and dry” locations that are gently sloped? Dry lots should be in locations towards the top of the slope where water has the ability to run off the lot. Anywhere that water accumulates is not an appropriate location for a dry lot. You also want to find an area that is moderately sloped to encourage drainage of the site, but not too sloped or you might end up with erosion on the site.
- Will the location allow for a buffer from the dry lot? Since dry lots are not roofed, and animals will be congregated at the site, any runoff will collect nutrients. Vegetated buffers should be installed around the dry lot to capture any runoff and nutrients.
- Does your dry lot need an improved surface? Depending on the anticipated intensity of use of the dry lot, you may want to consider an improved surface like gravel or concrete. Gravel dry lots can withstand more use than a dirt dry lot, but they are harder to maintain and clean. Concrete dry lots are capable of withstanding very heavy usage and are easier to maintain, however they are much more costly.
- Are there any buildings or landscape features around your dry lot that will contribute water? Chances are your dry lot will be located next to a barn or turnout shed. To keep your dry lot dry, any water coming into the dry lot should be redirected to avoid adding unnecessary water on your lot. Overland flows can be diverted from the dry lot and water coming from rooftops can be diverted using gutters and outlets. Contact your local NRCS office if you are having or think you will have water issues on your dry lot.

CRMDBDSC

Compost Bedded Pack Barns

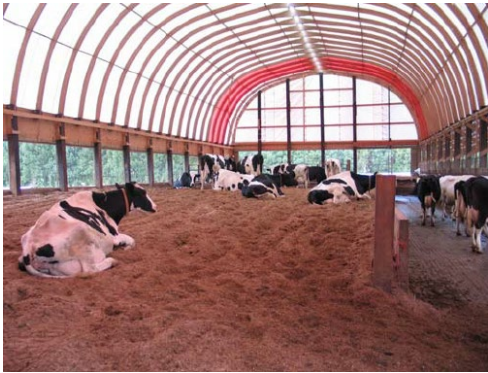

Photo Links:

[Left: Holsteins in compost bedded pack barn](#)

[Right: Bred cows in pack barn](#)

Much like dry lots, compost bedded pack barns provide a space for animals to go when conditions are not conducive to grazing. Unlike dry lots, that can be used in the short and long term, compost bedded pack barns are better used for longer confinement periods, like overwinter, to maximize their benefits.

These are called compost bedded pack barns, because they do exactly what they sound like – compost bedding and manure in place throughout the confinement period. Because of this, the materials in the barn are constantly breaking down which has multiple benefits to the producer and the animals:

- As the materials compost in place and breakdown, there is less need for cleanouts
- The composting process generates heat so in the wintertime the barns can be quite comfortable for the animals and the farmers
- When the materials are cleaned out, they should be fully composted and require no additional treatment before spreading evenly on the fields.

While these barns have many benefits there are a few drawbacks, mainly in the cost and the labor. If you don't already have a barn that is suitable to convert to a compost bedded pack barn there is a high initial investment cost. Labor is also high to maintain the composting process. Specific mixtures of straw, wood chips, shavings, and other materials need to be sourced and used in the barn to promote the composting process. These materials also need to be maintained. Often the barns are "tilled" or "raked" multiple times a week, and sometimes daily, to promote proper aeration and mixing of materials needed for the composting process.

Bale Grazing

Bale grazing is a method that allows animals to stay outside for longer into the winter season. The supplemental feed (hay bales) are brought to the pastures and hay fields. This method allows for consumed nutrients to be deposited back into the pastures or hay fields, rather than being collected in a confinement area and spread. Feeding hay bales in the field also adds a great deal of organic matter directly around where the bales were placed.

In the short term, it may look like this technique increases bare areas in the field, but when done properly we can achieve the following soil health benefits:

- Increased above ground and below ground biomass because of an increase of organic matter and nutrients
- Increased biodiversity if bale grazing on hay fields that have not had previous animal activity



Photo: http://www.angusbeefbulletin.com/extra/2017/05may17/0517mq_bale-graze.html#.YmqaPujMKM9

Breakout #2

1. From the soil health practices shared today, which one(s) would you like to try in your operation? (List them in order of importance to you).

[some practices discussed: soil amendments, grazing type/stocking density, forage type, nutrient distribution, residual plant height, livestock diversity, dung beetles, overwintering solutions]

- 1.
- 2.
- 3.

2. List what action steps you plan to take to enact the practice(s) you listed above. (Keep in mind the challenges you wrote down during breakout session 1)

Practice:

- 1.
- 2.

Practice:

- 1.
- 2.

Practice:

- 1.
- 2.

4. What other questions/comments do you have about making change to soil health in your operation?

Overview of Grazing Systems

Every operation has a unique set of challenges and opportunities. Sometimes moving from a grazing system that provides a low amount soil health benefit to a system providing high soil health benefits is an easy transition, and other times it will require more management, time, labor, money, etc. While the goal is to achieve an adaptive grazing system, as shown all the way to the right of the diagram below, sometimes small shifts from left to right are all a land or herd manager can take on – and that is okay! Learning to hone in on a grazing system that works for you can take years of trial and error and experience. Don't get discouraged throughout the process if something doesn't work out the first time you try it. Also don't be afraid to take a few risks and try out new techniques, even if on just a small portion of your operation to start.



United States Department of Agriculture

Grazing Effects on Soil Health

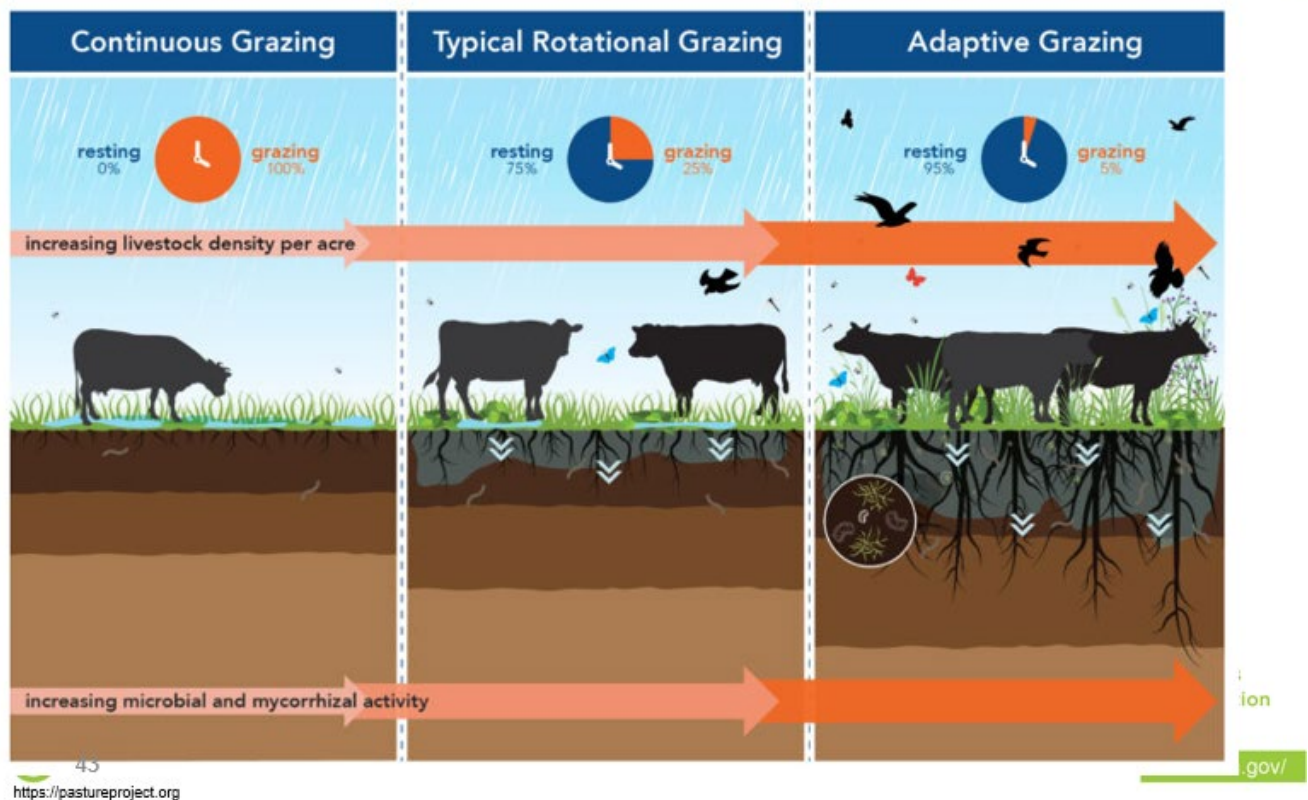

Below are some further explanations of continuous, rotational, and adaptive grazing management strategies, how they relate to the soil health principles and a few opportunities each type of grazing management presents. Each management system builds on the next. Can you think of other examples of challenges and opportunities within each of the below systems?

Continuous Grazing

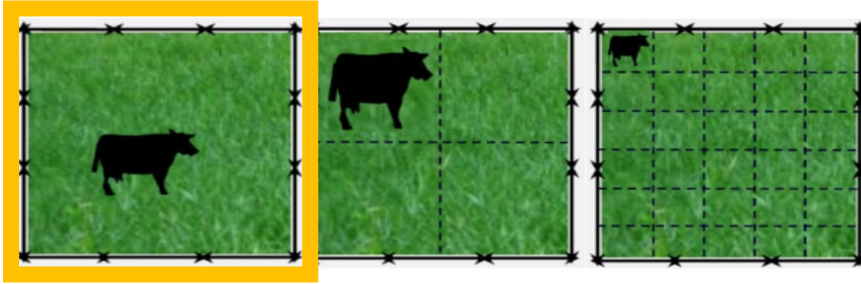

Overview of Continuous Grazing Management

Pros: Low labor, low cost

Cons: Low production, low soil health benefits

Soil Health Benefits and/or Challenges

Minimize Disturbance

- Risk of over grazing (remember utilization rates)
- High erosion potential

Maximize Growing Root

- Roots reserves are often depleted
- More thatch leads to shading of new plants

Increase Soil Coverage

- Low grazing heights (spatial memory)

Increase Biodiversity

- Often only includes one or two species of less production

Continuous Grazing Opportunities

Minimize Disturbance

- Utilize dry lots/sacrifice areas
- Monitor, monitor, monitor

Maximize Growing Root

- Utilize dry lots/sacrifice areas

Increase Soil Coverage

- Utilize dry lots/sacrifice areas

Increase Biodiversity

- Utilize dry lots/sacrifice areas
- Most likely more overseeding, allowing for manipulation of species

Rotational Grazing

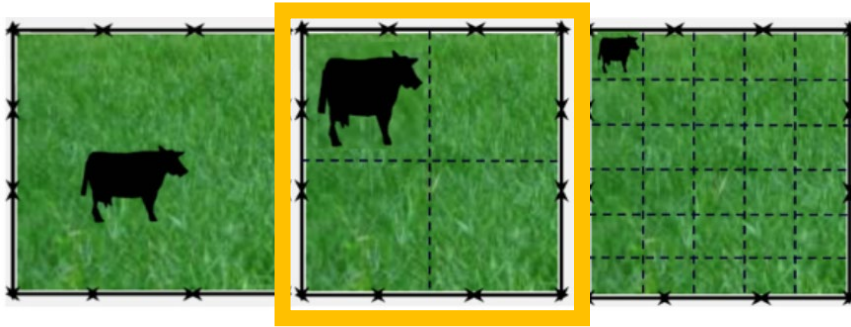

Overview of Rotational Grazing Management

Pros: Maintainable for busy folks

Cons: Middle ground for production and management

Soil Health Benefits and/or Challenges

Minimize Disturbance

- Moderate risk of overgrazing, monitoring will mitigate this risk

Maximize Growing Root

- Moving animals more frequently will encourage more plant production, above and below ground

Increase Soil Coverage

- Animals will have better utilization in the pastures (even grazing)

Increase Biodiversity

- Typically rotational grazing includes moderate diversity within animal and forage species

Continuous Grazing Opportunities

Minimize Disturbance

- Utilize dry lots/sacrifice areas
- Monitor, monitor, monitor
- Plan rotations based on soil characteristics

Maximize Growing Root

- Utilize dry lots/sacrifice areas
- Mow after moving animals to maintain vegetative state of forages

Increase Soil Coverage

- Utilize dry lots/sacrifice areas
- Mow behind animals to maintain vegetative stage

Increase Biodiversity

- Utilize dry lots/sacrifice areas
- Experiment with annuals
- Explore multi-species grazing

Adaptive Grazing (High Intensity)

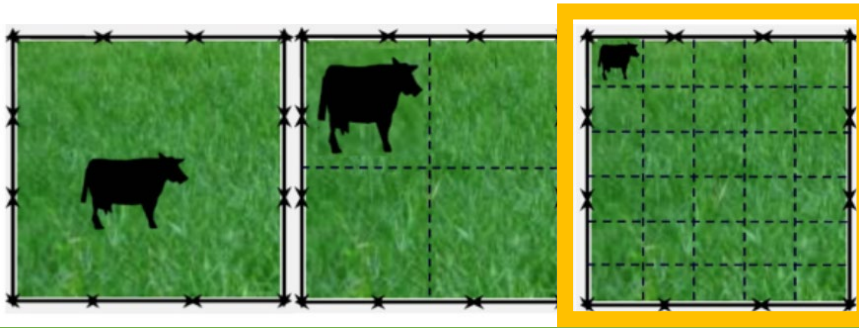

Overview of Adaptive Grazing Management

Pros: High production with the greatest soil health benefits

Cons: Higher infrastructure costs, high labor, and management. There is a risk of overgrazing and compaction if not management properly

Soil Health Benefits and/or Challenges

Minimize Disturbance

- Animals are rotated depending on site conditions, minimizing erosion and compaction

Maximize Growing Root

- Greater season extension
- Promotes better nutrient distribution

Increase Soil Coverage

- Greater season extension
- Promotes better nutrient distribution

Increase Biodiversity

- Appropriate timing encourages biodiversity in plants
- Animal species above and below ground increase

Continuous Grazing Opportunities

Minimize Disturbance

- Utilize dry lots/sacrifice areas
- Monitor, monitor, monitor
- Plan rotations based on soil characteristics

Maximize Growing Root

- Utilize dry lots/sacrifice areas
- Mow after moving animals to maintain vegetative state of forages
- Introduce annuals for winter grazing

Increase Soil Coverage

- Utilize dry lots/sacrifice areas
- Mow behind animals to maintain vegetative stage
- Bale grazing

Increase Biodiversity

- Utilize dry lots/sacrifice areas
- Rely on annuals for renovations or year-round grazing
- Use multiple grazing species to fully utilize pastures